

LIVING ENVIRONMENT

The University of the State of New York
REGENTS HIGH SCHOOL EXAMINATION

LIVING ENVIRONMENT

Thursday, August 13, 2009 — 12:30 to 3:30 p.m., only

Student Name _____

School Name _____

Print your name and the name of your school on the lines above. Then turn to the last page of this booklet, which is the answer sheet for Part A and Part B-1. Fold the last page along the perforations and, slowly and carefully, tear off the answer sheet. Then fill in the heading of your answer sheet.

You are to answer all questions in all parts of this examination. Write your answers to the Part A and Part B-1 multiple-choice questions on the separate answer sheet. Write your answers for the questions in Parts B-2, C, and D directly in this examination booklet. All answers should be written in pen, except for graphs and drawings which should be done in pencil. You may use scrap paper to work out the answers to the questions, but be sure to record all your answers on the answer sheet and in this examination booklet.

When you have completed the examination, you must sign the statement printed on your separate answer sheet, indicating that you had no unlawful knowledge of the questions or answers prior to the examination and that you have neither given nor received assistance in answering any of the questions during the examination. Your answer sheet cannot be accepted if you fail to sign this declaration.

Notice...

A four-function or scientific calculator must be made available for you to use while taking this examination.

The use of any communications device is strictly prohibited when taking this examination. If you use any communications device, no matter how briefly, your examination will be invalidated and no score will be calculated for you.

DO NOT OPEN THIS EXAMINATION BOOKLET UNTIL THE SIGNAL IS GIVEN.

Part A

Answer all questions in this part. [30]

Directions (1–30): For *each* statement or question, write on your separate answer sheet the *number* of the word or expression that, of those given, best completes the statement or answers the question.

- 1 Organisms that are able to manufacture organic nutrients from substances in the abiotic environment are classified as
 - (1) heterotrophs
 - (2) fungi
 - (3) predators
 - (4) autotrophs
- 2 Which factor would have the greatest effect on the flow of energy into an ecosystem?
 - (1) a large decrease in the amount of sunlight available
 - (2) a large increase in the number of carnivores
 - (3) a small increase in the number of decomposers
 - (4) a small decrease in the amount of minerals available
- 3 Which structures carry out life functions within cells?
 - (1) tissues
 - (2) organ systems
 - (3) organelles
 - (4) organs
- 4 Which process is most directly responsible for maintaining internal stability in an organism when its environment is constantly changing?
 - (1) digestion
 - (2) feedback
 - (3) reproduction
 - (4) evolution
- 5 The function of a cell depends primarily on its
 - (1) life span
 - (2) color
 - (3) structure
 - (4) movement
- 6 In some cases, humans have chosen to mate certain individual farm animals within a species. For example, by allowing only the largest cattle to reproduce over many generations, strains of very large cattle have been produced. This process is known as
 - (1) natural selection
 - (2) direct harvesting
 - (3) selective breeding
 - (4) dynamic equilibrium
- 7 A boy inherits genes for tallness, but his growth is limited as a result of poor nutrition. This is an example of
 - (1) an inherited disorder
 - (2) environmental influence on gene expression
 - (3) expression of a hidden trait
 - (4) a characteristic controlled by more than one pair of genes
- 8 The sickle-cell trait is an inherited condition resulting from the presence of abnormal molecules of the protein hemoglobin in red blood cells. A person with the sickle-cell trait may have a child with the same condition because the child receives from the parent
 - (1) abnormal red blood cells
 - (2) abnormal hemoglobin molecules
 - (3) a code for the production of abnormal hemoglobin
 - (4) a code for the production of abnormal amino acids
- 9 The sorting and recombining of genes during meiosis and fertilization usually leads to the production of
 - (1) gametes with many copies of the same chromosome
 - (2) embryos with traits identical to those of all other members of the species
 - (3) zygotes with the genetic information to produce only females
 - (4) offspring with some traits that did not appear in their parents
- 10 Which situation would most likely produce a gene mutation in a squirrel?
 - (1) The squirrel stops using its claws for digging.
 - (2) The squirrel is exposed to radiation for several days.
 - (3) Oak trees gradually become less common.
 - (4) The weather becomes wetter for a short period of time.

11 Which row in the chart below best describes what happens when some DNA bases are deleted from a gene?

Row	Gene	Trait Controlled By the Original DNA
(1)	is not changed	is never changed
(2)	is not changed	may be changed
(3)	is changed	is never changed
(4)	is changed	may be changed

12 The diagram below represents a technique currently used by scientists in the field of biotechnology.

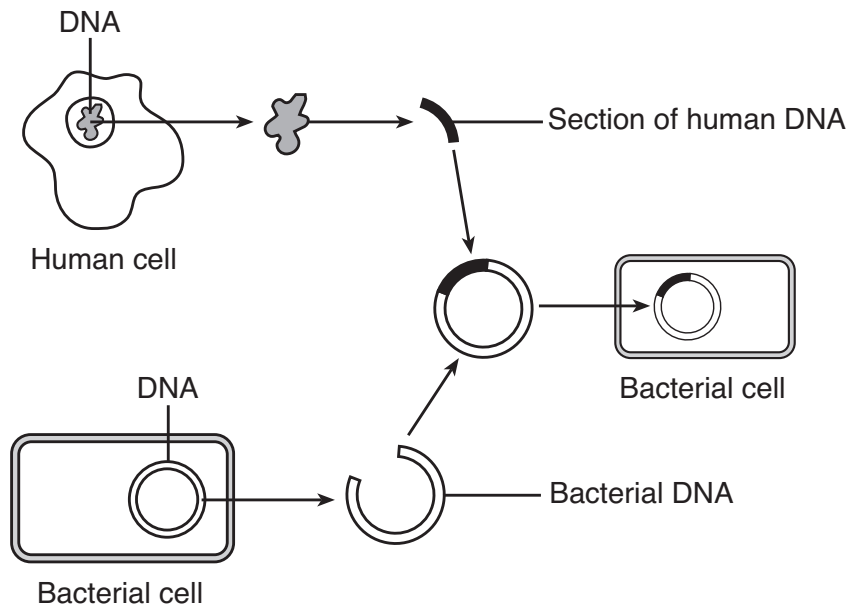

Which statement describes a possible outcome of this technique?

- (1) The bacterium is able to produce a human hormone.
- (2) It allows the bacterium to grow in humans, since it contains a human gene.
- (3) It allows humans to become immune to an infection from this type of bacteria.
- (4) The bacterium can now produce human cells identical to cells of the DNA donor.

- 13 When antibiotics were first developed, most infectious diseases could be controlled by them. Today, certain bacteria are resistant to many antibiotics. One possible explanation for this change is that
- (1) the antibiotics killed most of the bacteria that did not have a genetic variation for resistance
 - (2) the bacteria needed to change in order to produce more antibiotics
 - (3) some of the bacteria learned how to resist the antibiotics
 - (4) antibiotics have become weaker over the years
- 14 Thousands of genetically identical trees have been discovered growing in a remote, undisturbed mountain area in Colorado. These trees are most likely the result of
- (1) genetic engineering
 - (2) asexual reproduction
 - (3) meiotic cell division
 - (4) biotechnology
- 15 The ability of the human body to keep blood-sugar levels within a fairly narrow range, despite the intake of meals high in carbohydrates, is an example of
- (1) active transport
 - (2) genetic recombination
 - (3) homeostasis
 - (4) digestion
- 16 A large number of sperm cells are produced by males every day. This large number of sperm cells increases the chance that
- (1) at least one sperm cell will be reached when the eggs swim toward the sperm cells in the ovary
 - (2) several sperm cells will unite with an egg so the fertilized egg will develop properly
 - (3) some of the sperm cells will survive to reach the egg
 - (4) enough sperm cells will be present to transport the egg from where it is produced to where it develops into a fetus
- 17 Which statement best describes the relationship between the blood of a human fetus and the blood of the mother?
- (1) Their blood systems are separate only at certain times in development and connected at other times.
 - (2) The blood flows directly from the mother into the fetus.
 - (3) Their blood systems are separate and no materials are exchanged.
 - (4) Their blood systems are separate, but certain materials pass from one to the other.
- 18 To replace burned skin, doctors can successfully transplant replacement skin taken from another part of the body of the burn victim. Which statement best explains why the transplanted skin is *not* rejected?
- (1) The transplanted skin is damaged, making the immune system nonfunctional.
 - (2) The antigens of the replacement skin are the same as those of the damaged skin.
 - (3) Burn victims lose so much blood that white blood cells cannot cause an immune response.
 - (4) There is no blood supply to the skin, so mixing of antigens does not occur.
- 19 The soil on a farm can very quickly become depleted of the minerals essential to plants because harvesting of crops can interfere with the
- (1) reproductive cycles of animals
 - (2) recycling of inorganic compounds
 - (3) flow of energy
 - (4) transport of groundwater
- 20 A vaccine used against an infectious disease may contain
- (1) specialized blood cells
 - (2) toxic enzymes
 - (3) a variety of antibiotics
 - (4) weakened pathogens

- 21 What will most likely occur if two different plant species compete for the same requirements in an ecosystem?
- (1) They will usually develop different requirements.
 - (2) One species may adapt to a different environment.
 - (3) One species may be eliminated from that ecosystem.
 - (4) They will alter the environment so that they can both survive in that ecosystem.
- 22 Some of the energy taken in by an organism is not available to other organisms in a food web. Energy that is *not* available to other organisms in a food web is energy that is
- (1) stored in the remains of a dead animal
 - (2) lost to the environment as heat
 - (3) stored in eggs produced during sexual reproduction
 - (4) produced in muscle tissue during the growth of an organism
- 23 The relationship that exists when athlete's foot fungus grows on a human is an example of
- (1) predator/prey
 - (2) producer/consumer
 - (3) parasite/host
 - (4) decomposer/autotroph
- 24 If an ecosystem is changed through a natural disaster, organisms will have the best chance of survival if
- (1) their environment has few abiotic factors
 - (2) the organisms are large
 - (3) the population size is small
 - (4) their species exhibits genetic variation
- 25 In state forests and parks containing varieties of flowering trees and shrubs, there are signs that say "Take nothing but pictures, leave nothing but footprints." These signs are necessary because
- (1) humans can destroy habitats by removing flowering trees and shrubs
 - (2) all animals feed directly on flowering shrubs that may be removed by people
 - (3) removal of flowering trees and shrubs will increase biodiversity
 - (4) flowering shrubs grow best in state forests and parks
- 26 Which human activity creates the *least* threat to global stability?
- (1) overuse of resources
 - (2) pollution of water with heavy metals
 - (3) pollution of air with sulfur gases
 - (4) reuse of plastic bags
- 27 Which change is a cause of the other three?
- (1) increased fossil fuel consumption
 - (2) destruction of the ozone shield
 - (3) increased industrialization
 - (4) destruction of natural habitats
- 28 In an attempt to improve environmental quality, local officials in a county in New York State want to build a garbage-to-steam plant. At the plant, garbage would be burned to produce energy, but air pollution would also be produced. In order to decide whether or not to build this plant, the community must consider
- (1) the trade-offs involved
 - (2) new genetic technology
 - (3) the natural process of succession
 - (4) energy flow between organisms

29 An evolutionary pathway is represented below.

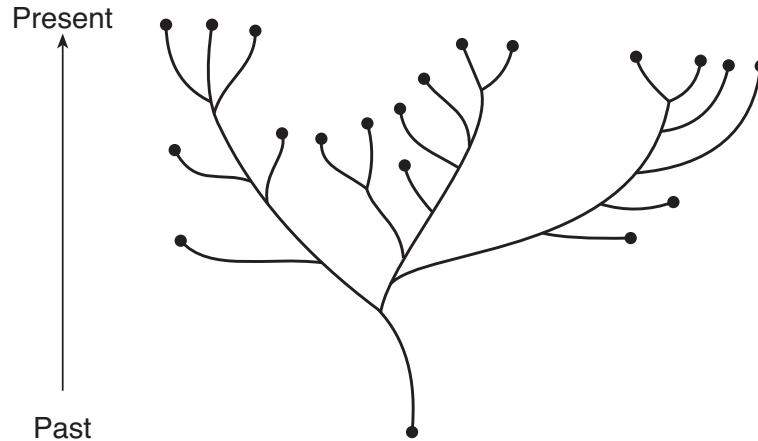

Which statement about evolutionary pathways is most accurate?

- (1) All evolutionary pathways show that life began with autotrophic organisms that soon evolved into heterotrophic organisms.
- (2) Two organisms on the same branch of an evolutionary pathway are more closely related to each other than to those on distant branches.
- (3) All the organisms shown at the ends of evolutionary pathway branch tips are alive today.
- (4) Evolutionary pathways show that evolution is a short-term process.

30 Which graph represents a population that grew and is maintained at the carrying capacity of its ecosystem?

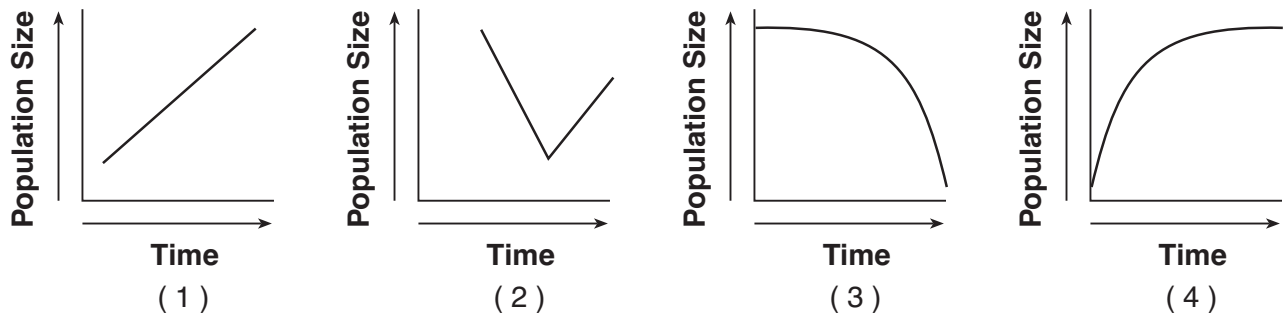

Part B-1

Answer all questions in this part. [13]

Directions (31–43): For *each* statement or question, write on the separate answer sheet the *number* of the word or expression that, of those given, best completes the statement or answers the question.

31 A laboratory procedure calls for heating 50 milliliters of a sugar solution to 60°C. Which piece of laboratory equipment will *not* be needed?

- (1) protective eyewear
- (2) ruler
- (3) thermometer
- (4) graduated cylinder

32 Which statement best describes a hypothesis?

- (1) A hypothesis is the process of making careful observations.
- (2) The conclusion drawn from the results of an experiment is part of a hypothesis.
- (3) A hypothesis serves as a basis for determining what data to collect when designing an experiment.
- (4) The facts collected from an experiment are written in the form of a hypothesis.

33 The diagram below represents a species of bee that helps one type of orchid plant reproduce by carrying pollen on structure X from one orchid flower to another. Pollination by this species of bee is the only way the orchid can reproduce.

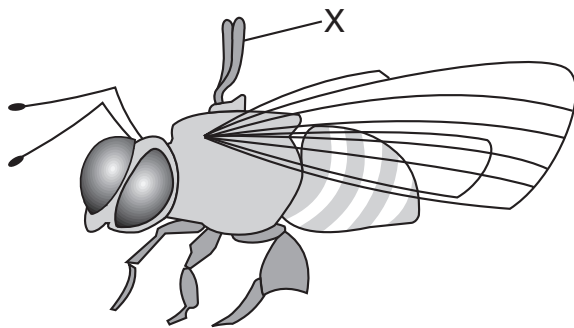

If this bee species dies out, this orchid species would most likely

- (1) cease to exist
- (2) find another animal to carry the pollen
- (3) flower at a different time of year
- (4) develop another way to reproduce

34 Which model best represents the relationship between a cell, a nucleus, a gene, and a chromosome?

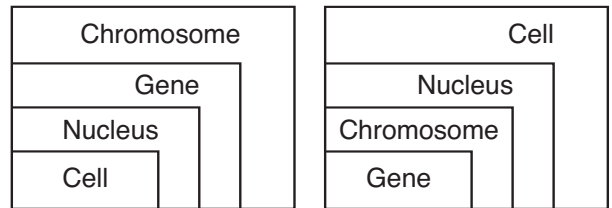

(1)

(3)

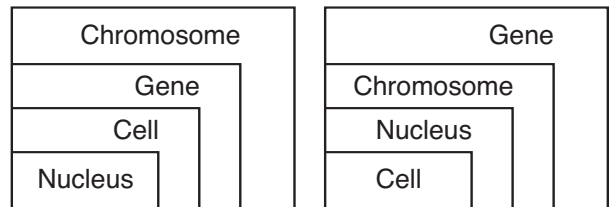

(2)

(4)

35 A researcher recently discovered a new species of bacteria in the body of a tubeworm living near a hydrothermal vent. He compared the DNA of this new bacterial species to the DNA of four other species of bacteria. The DNA sequences came from the same part of the bacterial chromosome of all four species.

Species	DNA Sequence
unknown species	ACT GCA CCC
species I	ACA GCA CCG
species II	ACT GCT GGA
species III	ACA GCA GGG
species IV	ACT GCA CCG

According to these data, the unknown bacterial species is most closely related to

- (1) species I
- (2) species II
- (3) species III
- (4) species IV

Base your answers to questions 36 and 37 on the passage below and on your knowledge of biology.

Alaska: Anchorage — Birders noted a sharp increase in European starlings in the 2005 Anchorage Christmas Bird Count. The sometimes aggressive species is relatively new to Alaska. Only three starlings were spotted during the 1995 Christmas bird count. Last year, there were 35. This year, birders counted 156.

Source: *USA Today*, 12/28/05

36 Which graph best represents the change in the number of starlings seen in the Anchorage area?

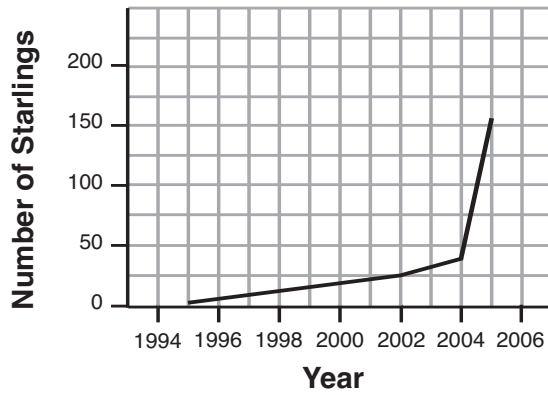

(1)

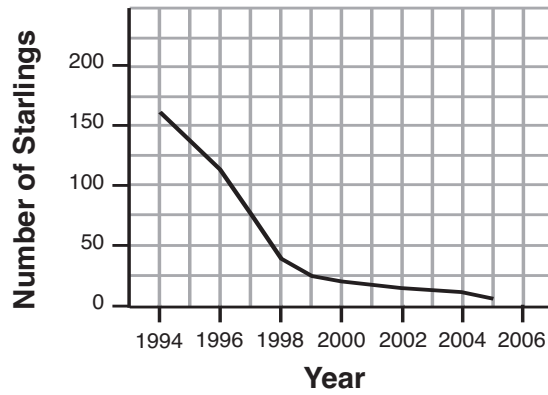

(3)

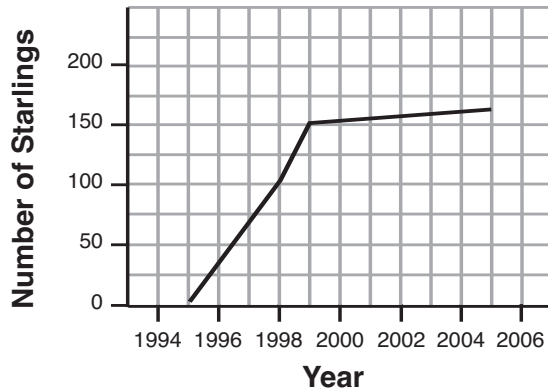

(2)

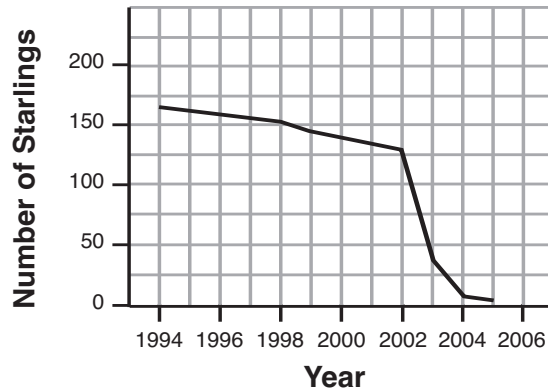

(4)

37 The change in the starling population in Anchorage from 1995 to 2005 could have been due to the presence of

- (1) a large population of competing species
- (2) a wide variety of predators
- (3) an abundant food supply
- (4) very few flowering plants

38 The diagram below represents the bones of the forelimbs of two animals alive today that most likely evolved from a common ancestor. Members of the original ancestral population were isolated into two groups by natural events.

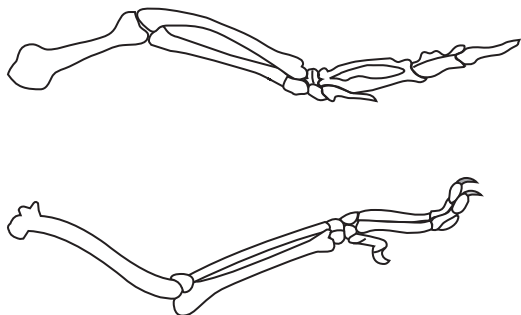

If these two animals did have a common ancestor, which statement would best explain why there are differences in the bones?

- (1) Changes occurred to help the animals return to their original environment.
- (2) Changes contributed to the survival of the organisms in their new environment.
- (3) Changes helped reduce competition within each group.
- (4) Changes indicate the species are evolving to be more like the ancestral species.

39 Within which structure shown in the diagram below are energy-rich organic compounds used to produce ATP?

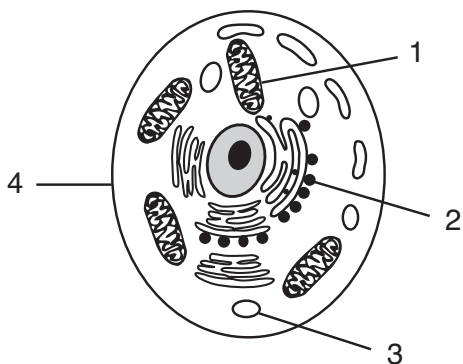

- (1) 1
- (2) 2
- (3) 3
- (4) 4

40 The graph below shows the relative concentrations of certain hormones in the blood during the human female reproductive cycle.

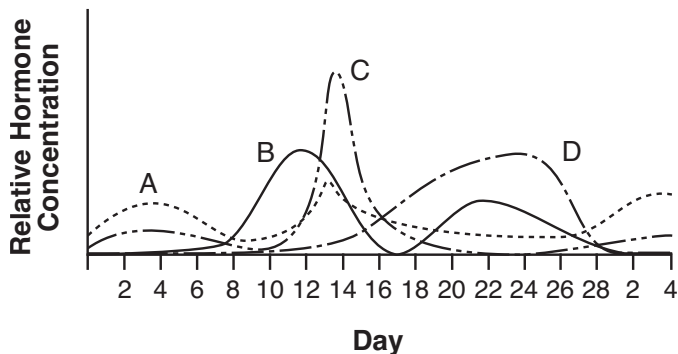

Which hormone has the lowest concentration on which day?

- (1) hormone A on day 4
- (2) hormone B on day 2
- (3) hormone C on day 12
- (4) hormone D on day 20

41 Which statement best describes the starch content of two leaves taken from the same plant shown in the chart below?

Leaf A	taken from plant in the dark for 48 hours
Leaf B	taken from plant in bright light for 48 hours

- (1) Neither leaf contains starch.
- (2) Both leaves contain the same amount of starch.
- (3) Leaf A contains more starch than leaf B.
- (4) Leaf B contains more starch than leaf A.

Base your answers to questions 42 and 43 on the diagram below, which represents a chemical reaction that occurs in the human body, and on your knowledge of biology.

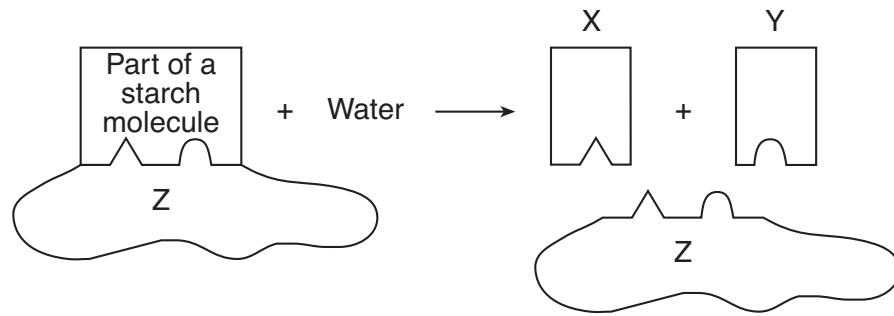

42 Substances *X* and *Y* are examples of which kind of molecule?

- (1) simple sugar
- (2) amino acid
- (3) fat
- (4) hormone

43 Which statement describes a characteristic of molecule *Z*?

- (1) Molecule *Z* will function at any temperature above 20°C.
 - (2) Molecule *Z* is composed of a string of molecular bases represented by A, T, G, and C.
 - (3) Molecule *Z* will function best at a specific pH.
 - (4) Molecule *Z* is not specific, so this reaction can be controlled by any other chemical in the body.
-

Part B-2

Answer all questions in this part. [12]

Directions (44–55): For those questions that are followed by four choices, circle the *number* preceding the choice that, of those given, best completes the statement or answers the question. For all other questions in this part, follow the directions given in the question and record your answers in the spaces provided.

Base your answers to questions 44 through 46 on the passage below and on your knowledge of biology.

**For Teacher
Use Only**

To most people, using maggots (fly larvae) for a medical treatment is not a great idea. However, to many doctors, fly larvae do have a place in medicine, and that place is inside open wounds.

In maggot debridement therapy, live fly larvae are mixed into a dressing for a wound and the area is covered with gauze. Maggots, which will only eat dead tissue, feed on damaged flesh and leave the healthy tissue behind. In the process, the maggots excrete an antimicrobial chemical that helps cleanse the wound of pathogens. When the dressing is cut away two or three days later, the maggots, now up to 10 times their original size, are easily removed.

People with diabetes often have impaired wound healing. This could lead to infection. Maggot therapy has been used to clean these types of wounds.

44 What is the meaning of the term *debridement*?

- (1) excretions of pathogens
- (2) impaired wound healing
- (3) removal of dead tissue
- (4) destruction of antimicrobial chemicals

44

45 Which group of terms best describes a maggot?

- (1) decomposer, prey, host
- (2) scavenger, heterotroph, consumer
- (3) producer, predator, parasite
- (4) pathogen, carnivore, autotroph

45

46 State *one* possible reason why slow healing of wounds can lead to infection. [1]

46

Base your answers to questions 47 through 50 on the information below and on your knowledge of biology.

**For Teacher
Use Only**

Hydrogen peroxide is a toxic substance produced in an organism as a result of certain metabolic processes. Catalase, a biological catalyst produced by cells, speeds the breakdown of hydrogen peroxide into less harmful substances.

In an investigation, 2-gram pieces of liver (which contains catalase) were added to separate dishes. Each dish contained the same amount of a 3% solution of hydrogen peroxide, but at different temperatures. The relative activity of the catalase was determined. The results were recorded and are shown in the data table below.

The Effect of Temperature on Catalase Activity

Temperature (°C)	Relative Catalase Activity
20	17
25	22
30	33
35	43
40	37
45	24
50	12

Directions (47–48): Using the information in the data table, construct a line graph on the grid on the next page, following the directions below.

47 Mark an appropriate scale on each axis. [1]

48 Plot the data, surround each point with a small circle, and connect the points. [1]

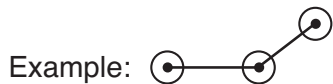

**The Effect of Temperature
on Catalase Activity**

Relative Catalase Activity

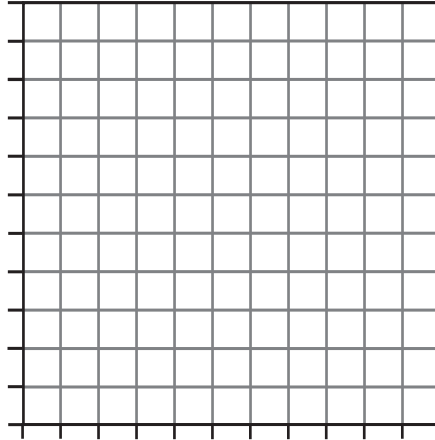

Temperature (°C)

**For Teacher
Use Only**

47

48

49 At which temperature does catalase work most effectively? Support your answer. [1]

49

50 What type of organic substance is catalase? [1]

50

Base your answers to questions 51 through 53 on the diagram of nerve cells below and on your knowledge of biology.

**For Teacher
Use Only**

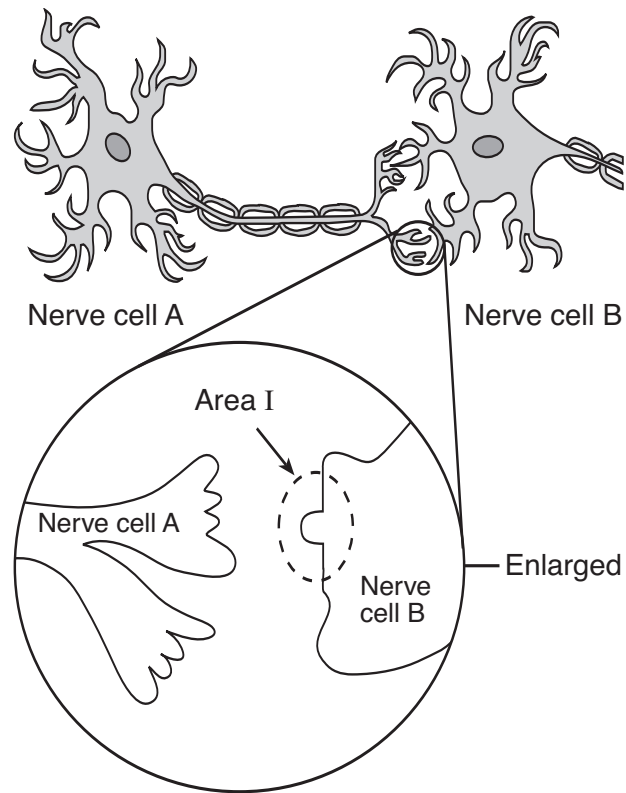

51 In the space below, sketch a chemical molecule that might be released from nerve cell A and be recognized and bind to area I of nerve cell B. [1]

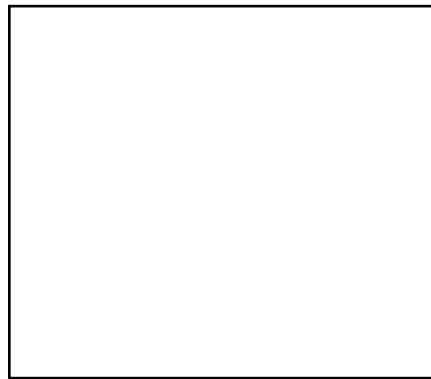

51

52 Describe what would happen if a drug molecule shaped like  were introduced into this nerve pathway. [1]

**For Teacher
Use Only**

52

53 Identify *one* substance, other than the secretions from nerve cells, used in cell communication. [1]

53

Base your answers to questions 54 and 55 on the information below and on your knowledge of biology.

If farm fields in the Piedmont region of North Carolina are abandoned, there is a regular sequence of plant species that will inhabit the field. The data table below shows a typical sequence of dominant plant species.

Changes in Dominant Plant Species

Years After Last Cultivation	Dominant Plant Species
0	crabgrass
1	horseweed
2	aster
3	broomsedge
5–15	shortleaf pine
50–150	oak trees

54 This regular sequence of plant species over the 150-year period is known as

- (1) degrading of the ecosystem
- (2) loss of biodiversity
- (3) ecological succession
- (4) biological evolution

54

55 If the oak forest is destroyed by fire and no other disturbances occur, which dominant plant species would most likely be found in the region 70 years after the fire? [1]

55

Part C

Answer all questions in this part. [17]

Directions (56–65): Record your answers in the spaces provided in this examination booklet.

Base your answers to questions 56 through 58 on the information below and on your knowledge of biology.

**For Teacher
Use Only**

A park with a small lake is home to a population of ducks. The building of a housing complex eliminates a nearby pond. Soon other ducks and waterbirds like geese and egrets come to live at this small lake.

56 State *one* specific way the new populations of birds may affect the original population of ducks. [1]

56

57 State *one* specific way the new populations of birds may change the abiotic factors of the environment in and around the lake. [1]

57

58 Predict *one* way the new populations of birds may affect the populations of plants that live in and around the lake. [1]

58

59 Two life functions performed by all living organisms are nutrition and respiration. Identify *two* other life functions that are essential for the survival of all living organisms. Explain how each of the two life functions you identified maintains homeostasis. [2]

Life Function: _____

Explanation: _____

Life Function: _____

Explanation: _____

**For Teacher
Use Only**

59

60 A population of bats feeds on flying insects. Some of these bats have a gene that results in much stronger flight muscles than those of the other bats in the area. Explain how this variation could lead to evolutionary change within this species of bat. In your answer, be sure to include an explanation of:

- competition within the bat population [1]
- survival of various individuals within the bat population [1]
- how the frequency of the trait for stronger flight muscles would be expected to change within the bat population over time [1]

60

61 Identify *one* activity of a mother that can disrupt fetal development and explain how this activity might affect the development of her fetus. [1]

61

Base your answer to question 62 on the list below and on your knowledge of biology. The list includes two processes involved in the development of a human fetus.

**For Teacher
Use Only**

Processes
mitosis
differentiation

62 Select *one* process from the list and describe its role in the development of a human fetus. In your answer be sure to:

- identify the process you selected
- state the role of this process in fetal development [1]
- identify the organ in the mother where this process occurs [1]

Process: _____

62

63 Describe the cycling of carbon in an ecosystem. In your answer be sure to:

- identify the inorganic carbon compound that is obtained by plants from the environment [1]
- identify the process plants use to form more complex organic molecules from this carbon compound [1]
- describe how herbivores use these complex organic molecules [1]
- identify the process herbivores use to return carbon to the environment [1]

63

Base your answers to questions 64 and 65 on the information below and on your knowledge of biology.

Windmill farms are being developed as alternative energy sources in some areas of the United States. Windmill farms convert energy from the wind into electricity.

64 State *one* reason why some residents might be concerned if windmill farms were planned for their part of the country. [1]

64

65 State *one* environmental reason why using windmills for energy might be preferred over using coal for energy. [1]

65

**For Teacher
Use Only**

Part D

Answer all questions in this part. [13]

Directions (66–78): For those questions that are followed by four choices, circle the *number* of the choice, that, of those given, best completes the statement or answers the question. For all other questions in this part, follow the directions given in the question and record your answers in the spaces provided.

66 The diagram below represents a laboratory apparatus.

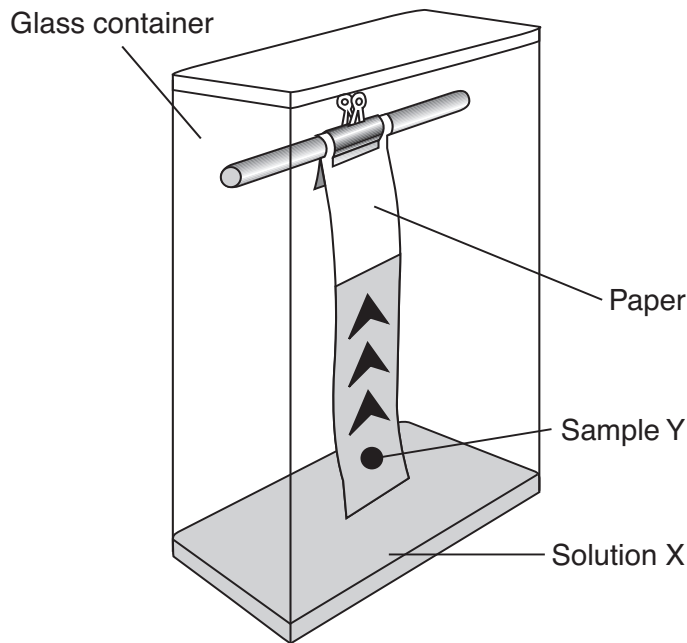

**For Teacher
Use Only**

This apparatus is used to

- (1) identify the molecular bases in DNA
- (2) detect chemical toxins in the air
- (3) stain specimens before observing them with a microscope
- (4) separate a mixture of plant pigments

66

Base your answers to questions 67 and 68 on the information and diagram below and on your knowledge of biology.

**For Teacher
Use Only**

Starch turns blue black in the presence of a starch indicator. Dialysis tubing tied at both ends and containing starch solution is placed in a beaker of water. Yellowish brown starch indicator is then added to the water.

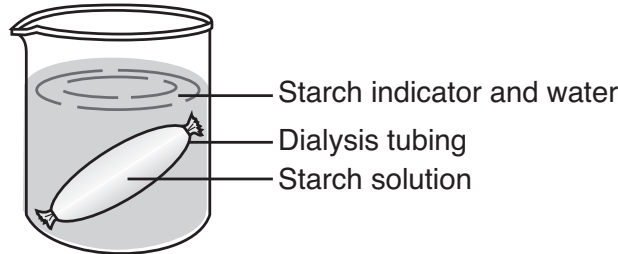

67 What will the solutions in the beaker and the tubing look like after 20 minutes?

- (1) The indicator solution in the beaker will be blue black and the starch solution in the tubing will not change color.
- (2) The starch solution in the tubing will be blue black and the indicator solution in the beaker will not change color.
- (3) Neither the indicator solution nor the starch solution will be blue black.
- (4) Both the indicator solution and the starch solution will be blue black.

67

68 This laboratory setup would most likely be used to demonstrate the process of

- (1) diffusion
 - (2) active transport
 - (3) replication
 - (4) cellular respiration
-

68

Base your answers to questions 69 through 71 on the chart below showing mRNA base sequences and the amino acids for which they code.

**For Teacher
Use Only**

**Universal Genetic Code Chart
Messenger RNA Codons and the Amino Acids for Which They Code**

		Second Base				
		U	C	A	G	
First Base	U	UUU } PHE UUC } UUA } LEU UUG }	UCU } UCC } SER UCA } UCG }	UAU } TYR UAC } UAA } STOP UAG }	UGU } CYS UGC } UGA } STOP UGG } TRP	U C A G
	C	CUU } LEU CUC } CUA } CUG }	CCU } CCC } PRO CCA } CCG }	CAU } HIS CAC } CAA } GLN CAG }	CGU } CGC } ARG CGA } CGG }	U C A G
	A	AUU } ILE AUC } AUA } AUG } MET or START	ACU } ACC } THR ACA } ACG }	AAU } ASN AAC } AAA } LYS AAG }	AGU } SER AGC } AGA } ARG AGG }	U C A G
	G	GUU } VAL GUC } GUA } GUG }	GCU } GCC } ALA GCA } GCG }	GAU } ASP GAC } GAA } GLU GAG }	GGU } GGC } GLY GGA } GGG }	U C A G

69 Which three codons would code for a different amino acid sequence from that coded for by the mRNA base sequence AGU-UCA-CCA?

- (1) AGC-UCU-CCU
- (2) AGU-UCC-CCG
- (3) AGC-UCA-CUU
- (4) AGU-UCG-CCC

69

70 Fill in an mRNA codon that would code for each amino acid shown. [1]

Amino acid: **ASP** **TRP** **CYS**

mRNA codon: _____ _____ _____

**For Teacher
Use Only**

70

71 Identify *one* of the mRNA codons that would stop the coding process. [1]

71

Base your answers to questions 72 through 74 on the information below and on your knowledge of biology.

A scientist conducted an experiment to test the hypothesis that maple seeds exposed to acid rain will take longer to germinate than seeds exposed to normal rain, which has a pH of 5.6. The scientist set up four groups, each containing 200 maple seeds. The water used for each group had a different pH value: 5.6, 4.0, 3.0, and 2.0. All other conditions were kept the same. After ten days, the number of seeds that had germinated in each group was counted.

72 Identify the control group in this experiment. [1]

72

73 Identify the dependent variable in this experiment. [1]

73

74 State *one* example of experimental results that would indicate that acid rain, which has a pH between 4.5 and 4.0, could be responsible for a *decrease* in the number of young maple trees in some forest regions. [1]

74

**For Teacher
Use Only**

75 A student squeezes a clothespin as rapidly as possible for one minute. Without stopping to rest, the student continues to squeeze the clothespin for a second minute. At the end of the second minute, the student's fingers and hand feel very cramped and tired. The physical tiredness and cramping in the muscles in the student's hand were most likely due to the increased production of

- (1) ATP
- (2) waste products
- (3) oxygen
- (4) glucose

75

76 A technique that can be used to compare the DNA of two or more plants is

- (1) cloning
- (2) chromatography
- (3) staining
- (4) gel electrophoresis

76

77 Three different species of finch inhabit one particular Galapagos Island. All three species of finch prefer plant food and have edge-crushing bills. Explain how all three species of finch can live successfully on the same island. [1]

77

78 Describe what will happen to red onion cells in a wet-mount slide when a saltwater solution is added to them. [1]

78

Tear Here

The University of the State of New York

REGENTS HIGH SCHOOL EXAMINATION

LIVING ENVIRONMENT

Thursday, August 13, 2009 — 12:30 to 3:30 p.m., only

ANSWER SHEET

Female

Student Sex: Male

Teacher

School Grade

Part	Maximum Score	Student's Score
A	30	
B-1	13	
B-2	12	
C	17	
D	13	
Total Raw Score (maximum Raw Score: 85)		<input type="text"/>
Final Score (from conversion chart)		<input type="text"/>
Raters' Initials		
Rater 1		Rater 2

Record your answers to Part A and Part B-1 on this answer sheet.

Part A

- | | | |
|----------|----------|----------|
| 1 | 11 | 21 |
| 2 | 12 | 22 |
| 3 | 13 | 23 |
| 4 | 14 | 24 |
| 5 | 15 | 25 |
| 6 | 16 | 26 |
| 7 | 17 | 27 |
| 8 | 18 | 28 |
| 9 | 19 | 29 |
| 10 | 20 | 30 |

Part A Score

Part B-1

- | | |
|----------|----------|
| 31 | 38 |
| 32 | 39 |
| 33 | 40 |
| 34 | 41 |
| 35 | 42 |
| 36 | 43 |
| 37 | |

Part B-1 Score

The declaration below must be signed when you have completed the examination.

I do hereby affirm, at the close of this examination, that I had no unlawful knowledge of the questions or answers prior to the examination and that I have neither given nor received assistance in answering any of the questions during the examination.

Signature

Tear Here

LIVING ENVIRONMENT

Tear Here

Tear Here

LIVING ENVIRONMENT